

FURUNO

OPERATOR'S MANUAL

COLOR VIDEO SOUNDER

MODEL FCV-667



FURUNO ELECTRIC CO., LTD.
NISHINOMIYA, JAPAN



SAFETY INSTRUCTIONS



WARNING



ELECTRICAL SHOCK HAZARD
Do not open the equipment.

Only qualified personnel should work inside the equipment.

Immediately turn off the power at the switchboard if water leaks into the equipment or something is dropped in the equipment.

Continued use of the equipment can cause fire or electrical shock. Contact a FURUNO agent for service.

Do not disassemble or modify the equipment.

Fire, electrical shock or serious injury can result.

Do not place liquid-filled containers on the top of the equipment.

Fire or electrical shock can result if a liquid spills into the equipment.

Immediately turn off the power at the switchboard if the equipment is emitting smoke or fire.

Continued use of the equipment can cause fire or electrical shock. Contact a FURUNO agent for service.

Make sure no rain or water splash leaks into the equipment.

Fire or electrical shock can result if water leaks in the equipment.



WARNING

Keep heater away from equipment.

A heater can melt the equipment's power cord, which can cause fire or electrical shock.

Use the proper fuse.

Fuse rating is shown on the equipment. Use of a wrong fuse can result in damage to the equipment.



CAUTION

A warning label is attached to the equipment. Do not remove the label. If the label is missing or illegible, contact a FURUNO agent or dealer.

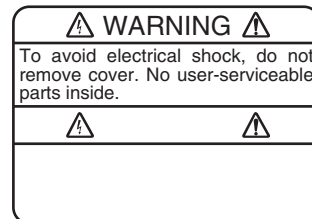

Name: Warning Label (1)
Type: 86-003-1011-0
Code No.: 100-236-230

TABLE OF CONTENTS

INTRODUCTION	iii	2.15 Alarms	2-14
PRINCIPLE OF OPERATION	v	2.16 White Marker	2-16
SYSTEM CONFIGURATION	vi	2.17 Demonstration Picture.....	2-16
1. CONTROLS, INDICATIONS	1-1	2.18 Correcting Speed/Water Temperature Readout	2-17
1.1 Control Description	1-1	3. INTERPRETING THE DISPLAY	3-1
1.2 Indications	1-2	3.1 Zero Line	3-1
2. BASIC OPERATION	2-1	3.2 Fish School Echoes	3-1
2.1 Turning the Power On/Off	2-1	3.3 Bottom Echo	3-1
2.2 Adjusting Brilliance.....	2-1	3.4 Surface Noise/Aeration	3-2
2.3 Display Mode Selection, Description ...	2-1	4. MAINTENANCE, TROUBLESHOOTING	4-1
2.4 Adjusting Gain	2-6	4.1 Maintenance	4-1
2.5 Automatic Operation	2-6	4.2 Basic Troubleshooting	4-3
2.6 Selecting Picture Advance Speed	2-7	4.3 Diagnostics	4-4
2.7 Display Range Selection	2-7	4.4 Transducer Check	4-5
2.8 Erasing Weak Echoes.....	2-8	4.5 Speed/Water Temperature Sensor (option) Check.....	4-5
2.9 Measuring Depth to a Fish School.....	2-9	4.6 Restoring Default Settings.....	4-5
2.10 A-scope Display	2-9	MENU TREE	A-1
2.11 Menu Operation	2-10	SPECIFICATIONS	SP-1
2.12 Suppressing Interference	2-13	INDEX	
2.13 Suppressing Low Level Noise	2-13		
2.14 Selecting Background and Echo Colors	2-14		

INTRODUCTION

Congratulations on your choice of the FURUNO FCV-667 Color Video Sounder. We are confident that you will enjoy many years of operation with this fine piece of equipment.

For over 50 years FURUNO Electric Company has enjoyed an enviable reputation for quality and reliability throughout the world. This dedication to excellence is furthered by our extensive global network of agents and dealers.

The FCV-667 is just one of the many FURUNO developments in the field of echo sounding. The compact, lightweight but rugged unit is easy to install and operate and is suitable for both fresh and saltwater applications.

This unit is designed and constructed to withstand the rigors of the marine environment. However, to obtain optimum performance from this unit, you should carefully read and follow the recommended procedures for operation and maintenance. No machine can perform to the utmost of its ability unless it is installed, operated and maintained properly.

We would appreciate feedback from you, the end-user, about whether we are achieving our purposes.

Thank you for considering and purchasing FURUNO equipment.

Features

The FCV-667 dual-frequency (50kHz and 200kHz) color video sounder has a large variety of functions, all contained in a splash-proof rugged plastic case that is compact to fit small boats.

The principal features of the FCV-667 are

- User-friendly design for simplified operation.
- A wide variety of display modes: bottom-lock expansion, marker zoom and unique bottom zoom displays.
- Potent 300 W transceiver.
- 8-color presentation (including background) on a 6" diagonal CRT, providing vivid presentation of underwater conditions.
- AUTO function permits unattended range and gain setting operations. The range scale and gain change automatically so that the bottom is displayed in reddish brown or red on the lower half of the screen.
- A-scope display gives excellent bottom fish discrimination, vital for bottom trawler and lobster/crab potter.
- Digital and analog displays of navigational data.

- Alarms: fish, bottom, water temperature (requires appropriate sensor).
- Six pulselengths for excellent performance on both shallow and deep ranges.
- Universal 12-24 VDC power supply drawing 30 W of power at maximum.
- Water temperature/speed sensor optionally available.

PRINCIPLE OF OPERATION

This Color Video Sounder determines the distance between its transducer and underwater objects such as fish, lake bottom or seabed and displays the results on a 6-inch color screen.

It does this by utilizing the fact that an ultrasonic wave transmitted through water travels at a nearly constant speed of 4800 feet (1500 meters) per second. When a sound wave strikes an underwater object such as fish or sea bottom, part of the sound wave is reflected back toward the source. Thus by calculating the time difference between the transmission of a sound wave and the reception of the reflected sound wave, the depth to the object can be determined. In a sense an echo sounder can be thought of as being an extremely sophisticated and quick timer, since it is capable of resolving time differences shorter than one thousandth of a second.

The entire process begins in the display unit. Transmitter power is sent to the transducer as a short pulse of electrical energy. The electrical signal produced by the transmitter is converted into an ultrasonic signal by the transducer and transmitted into the water. Any reflected signals from intervening objects (such as a fish school) are received by the transducer and converted back into an electrical signal. It is then amplified in the amplifier section, and finally, displayed on the screen.

The picture displayed by the color video sounder is made up of a series of vertical scan lines, one for each transmission. Each line represents a "snapshot" of what has occurred beneath the boat. The series of snapshots are accumulated side by side across the screen, and the resulting contours of the bottom and fish between the bottom and surface are displayed. The amount of history of objects that have passed beneath the boat over a series of transmission varies from less than a minute to a few minutes, depending on how you adjust the unit.

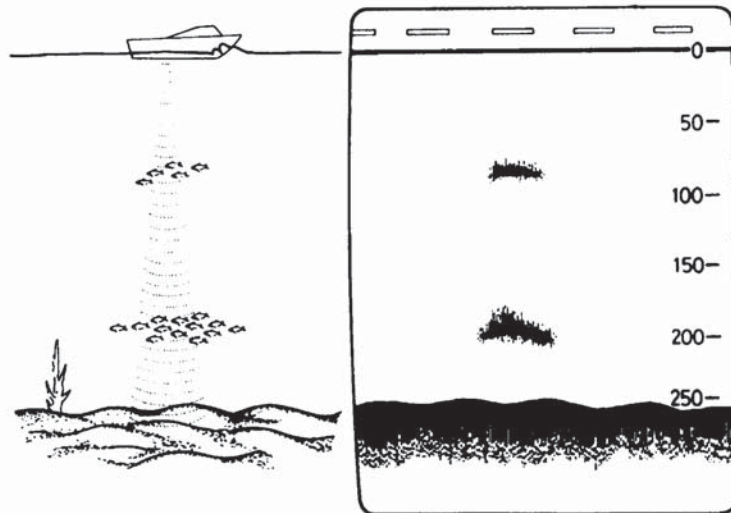

SYSTEM CONFIGURATION



**DISPLAY UNIT
CV-667**

TRANSDUCER
Standard supply
520-5PSC-A

Optional supply
520-5PWC
520-5MSC-A
520ST-PWA
524ST-MSA

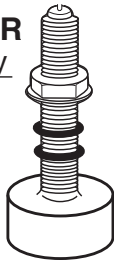

SPEED, TEMPERATURE SENSOR (option)
Speed/temperature sensor
ST-02MSB
ST-02PSB
ST-01PTB

Temperature sensor
T-02MTB
T-02MSB
T-03MSB

Ship's mains
12-24 VDC

External equipment
(GPS navigator, etc.)

1. CONTROLS, INDICATIONS

1.1 Control Description

The equipment is so designed that even a first time user can quickly become acquainted with the operating procedure. Operation of each control or key is acknowledged by an alphanumeric message or symbol indication on the screen.



Control	Function
SHIFT-, SHIFT+ (Appears in text as [-], [+].)	<ul style="list-style-type: none"> • Change display start depth. • Select options on menus.
BRILL	Adjusts brilliance of display.
AUTO	Turns the automatic sounder adjustment feature on/off.
ADVANCE (BRILL + AUTO)	Pressing the BRILL and AUTO keys together selects display advancement speed.
SIG LEV	Eliminates low intensity echoes (up to light-blue echoes) in two steps.
ALARM	Opens/closes the alarm menu.
A-SCOPE (SIG LEV + ALARM)	Pressing the SIG LEV and ALARM keys together displays the A-scope display at the right 1/4 of the screen.
MARKER ▲, MARKER ▼ (Appears in text as [▲] or [▼].)	<ul style="list-style-type: none"> • Shift the Variable Range Marker (VRM). • Set alarm zone. • Select menu items. • Set white marker.
RANGE	Sets the basic range of the display.
GAIN	Adjusts receiver sensitivity.
MODE	<ul style="list-style-type: none"> • Turns unit on/off. • Selects display mode.

1.2 Indications

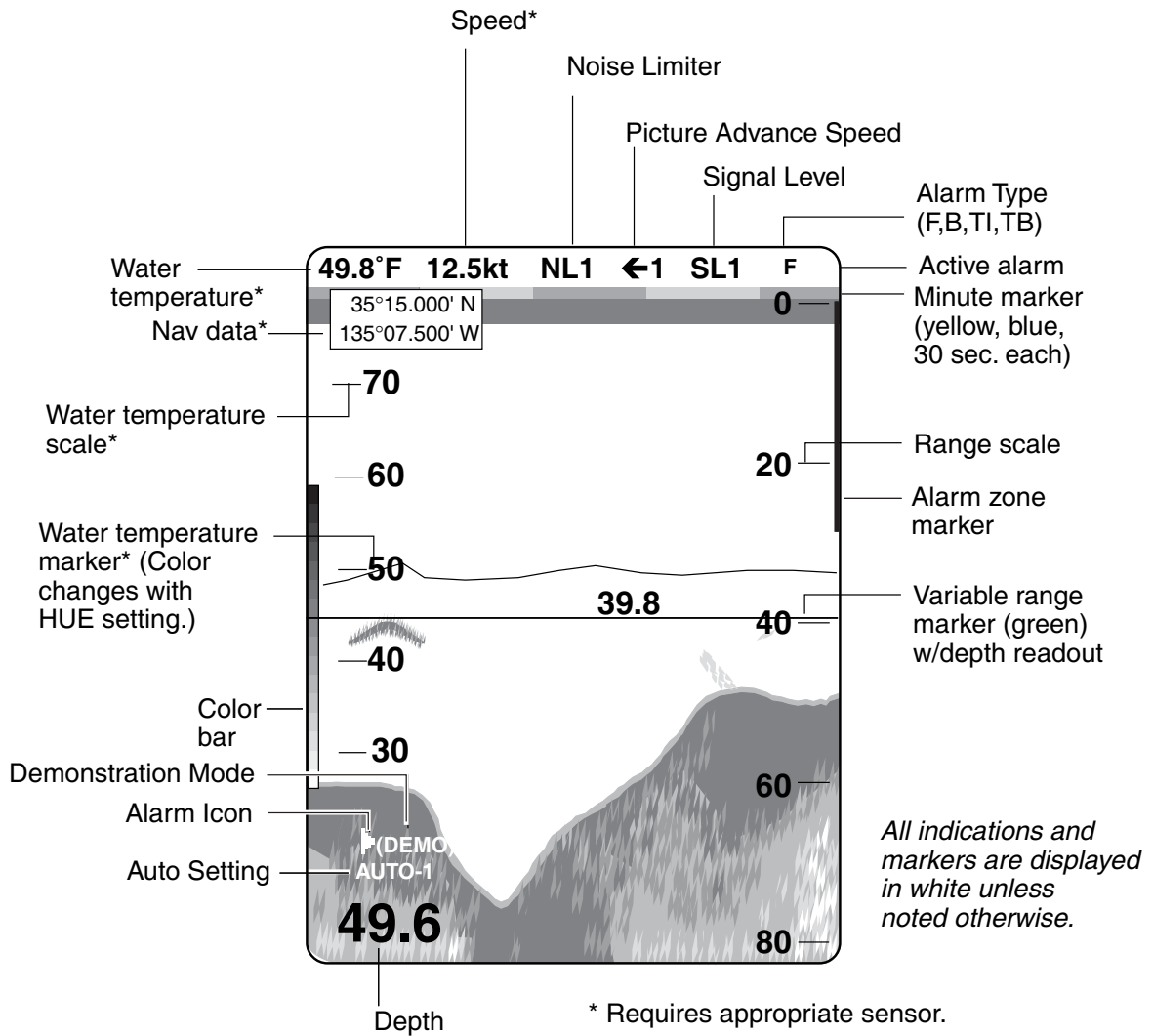

2. BASIC OPERATION

2.1 Turning the Power On/Off

Turn the [MODE] switch clockwise to turn the power on. The unit starts with the settings used before it was turned off last time. Note that there is a few seconds delay prior to display of the picture until the CRT warms up. To turn the power off, turn the switch fully counterclockwise.

2.2 Adjusting Brilliance

Use the [BRILL] key to adjust the brilliance. The selected brilliance level is shown on the display as below. There are six levels of brilliance including off. Keep the brilliance moderate to extend the life of the CRT.

BRILL: 0

2.3 Display Mode Selection, Description

2.3.1 Display mode selection

Seven display modes are available and you may select one of them with the [MODE] switch.

MODE switch description

MODE Switch Position	Function
HF	Provides the high frequency (200 kHz) normal picture on the full screen.
LF	Displays the low frequency (50 kHz) normal picture on the full screen.
DUAL	Displays the normal display for high frequency (200 kHz) on right half and that for the low frequency (50 kHz) on the left half.
HF ZOOM	Shows the normal display of the high frequency (200 kHz) on right half and its zoom display on the left half.
LF ZOOM	Provides the normal display of the low frequency (50 kHz) on right half and its zoom display on the left half.
NAV	Shows navigation data in analog or digital form (depending on menu setting) on the full screen.
MENU	Displays the main and system menus.

2.3.2 Display mode description

HF, LF (high frequency, low frequency) mode

The sounder uses ultrasonic pulses to detect bottom conditions. The lower the frequency of the pulse the wider the detection area. Therefore, the 50 kHz frequency is useful for general detection and judging bottom conditions, while the 200 kHz frequency is useful for detailed observation of fish schools.

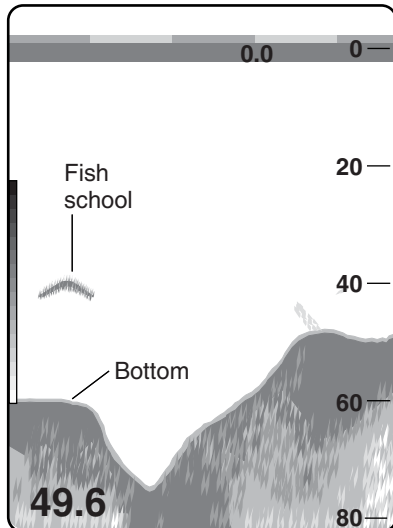

DUAL frequency mode

This mode provides the 50 kHz picture on the left-half of the screen and the 200 kHz on the right half, and is useful for detecting fish schools which have different reflection characteristics with frequency. For example, a school of tiny fish like minnow returns stronger echoes on a high frequency compared to a low frequency.

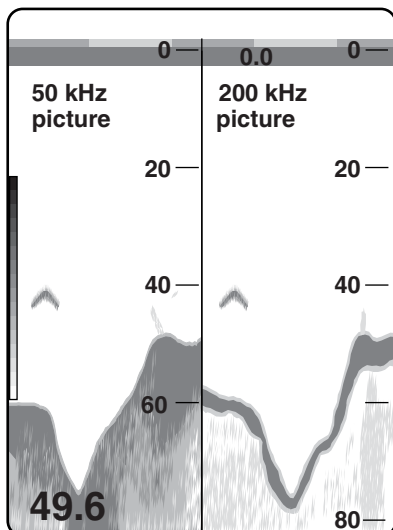

ZOOM mode (high or low frequency)

Three types of zoom displays are available: bottom-lock expansion, bottom zoom and marker zoom. The zoom mode to be used can be selected on the main menu with ZOOM MODE.

<p>BOTTOM-LOCK</p>	<p>This display provides a compressed normal picture on the top 2/3 of the screen and a 5 or 10 meter (10 or 20 feet) wide layer in contact with the bottom is expanded onto the bottom 1/3 of the screen. This mode is useful for bottom discrimination. Note that the seabed should be steadily and distinctly plotted in red or reddish-brown. Adjust the gain if necessary.</p> <p>Note 1: The bottom-lock range can be selected on the system menu [3].</p> <p>Note 2: The zoom marker can be turned on/off on the system menu [1].</p>
<p>BOTTOM ZOOM</p>	<p>This mode expands bottom and bottom fish echoes two to five times to vertical size of the screen, and it is useful for determining bottom hardness. A bottom displayed with a short echo tail usually means it is a soft, sandy bottom. A long echo tail means a hard bottom.</p> <p>The zone automatically moves so that the bottom echoes locate on the lower half of the screen.</p> <p>Note 1: The amount of expansion can be selected on the system menu [3].</p> <p>Note 2: The zoom marker can be turned on/off on the system menu [1].</p>
<p>MARKER ZOOM</p>	<p>This mode expands selected area of the normal picture to full vertical size of the screen on the left-half window. You may specify the portion to expand with the VRM (Variable Range Marker), which you can shift with [▲] or [▼]. The area between the VRM and the zoom range marker is expanded. The length of the segment is equal to one division of the depth scale.</p>

NAV mode

This mode shows navigation data digitally or graphically. The nav display to use can be selected on the system menu [1] with NAV.

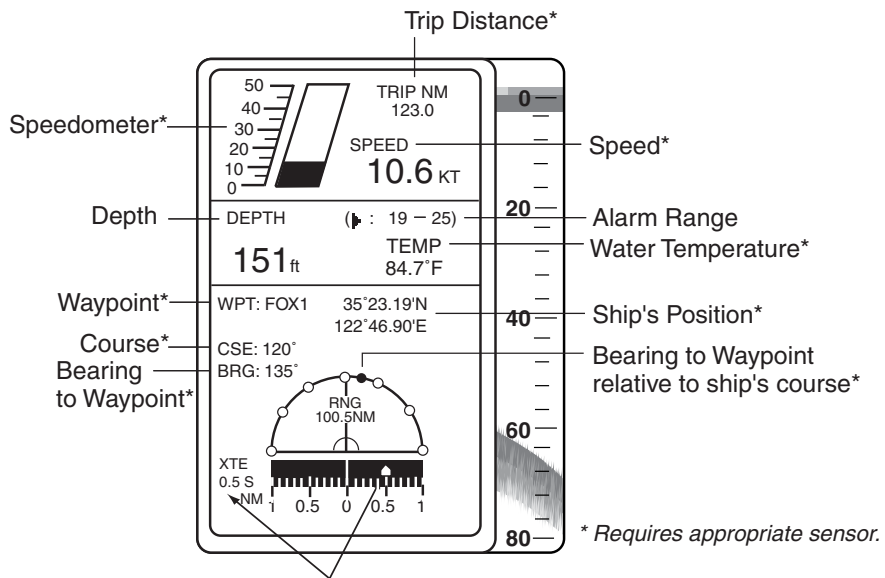

Cross-Track Error*
 (Shows amount and direction to steer to return to course. The example shows you should steer 0.5 nm starboard to return to course.)

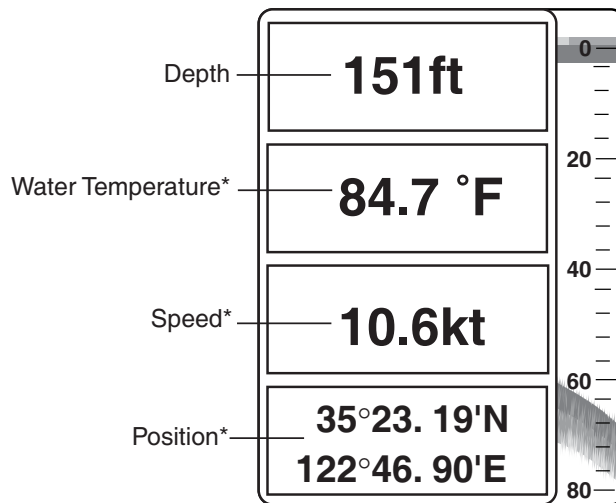

Enlarging a nav data indication

You can enlarge and display one of the data indications as follows.

1. Press [▲] or [▼] to select the indication which you want to enlarge. For example, select the depth indication.
2. Press the [+] key to enlarge the data.

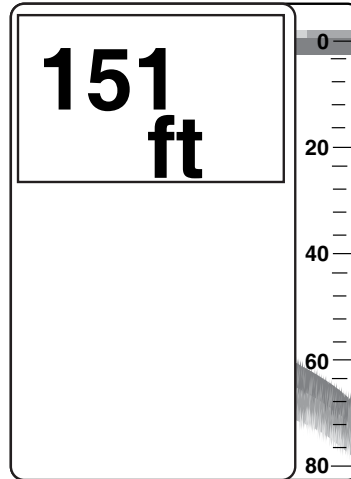

3. To return to the full data display, press the [-] key.

2.4 Adjusting Gain

The [GAIN] control adjusts the sensitivity of the receiver. Adjust it so that a slight amount of noise remains on the screen. Generally, use a higher gain setting for greater depths and a lower setting for shallower waters.

Note: The [GAIN] control is inoperative when the automatic mode is active.

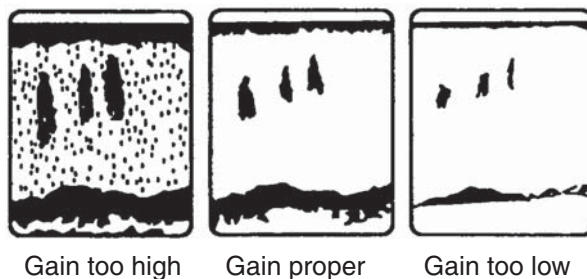

2.5 Automatic Operation

Automatic operation is useful when you are preoccupied with other tasks and do not have time to adjust the display.

2.5.1 How it works

The automatic function automatically selects the proper gain and range scale according to depth. It works as follows:

- The range changes automatically to locate the bottom on the lower half of the screen. It jumps to one step shallower range when bottom echoes reach a halfway point of the full scale from top and to one step deeper range when they come to the lower edge of the scale.
- The gain is automatically adjusted to display the bottom echo in reddish-brown (default color arrangement).
- Clutter level (on the main menu), which suppresses low level noise, is automatically adjusted.

2.5.2 Enabling automatic operation

Two types of automatic modes are available: AUTO 1, for fishing, and AUTO 2, for cruising. Since cruising uses a higher clutter rejection setting than fishing, it is not recommended for detection of fish because weak fish echoes may be deleted by clutter rejection. Note that the [SHIFT] keys ([+], [-]), [RANGE] switch and [GAIN] control are inoperative in the auto mode.

Press the [AUTO] key. Each press of the key turns the auto function on or off in the sequence shown below.

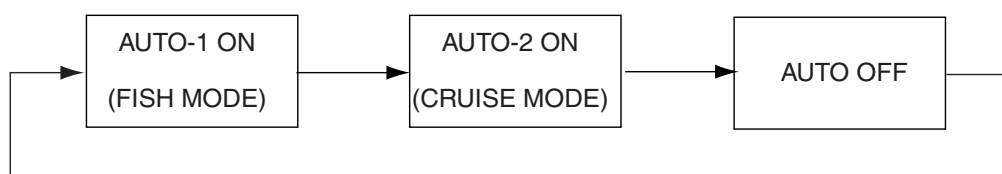

2.6 Selecting Picture Advance Speed

The picture advance speed determines how quickly the vertical scan lines run across the screen. When selecting a picture advance speed, keep in mind that a fast advance speed will expand the size of the fish school horizontally on the screen and a slow advance speed will contract it.

1. Press the [BRILL] and [AUTO] keys together. The display should look something like the one below. The fraction shown on the display denotes number of scan lines produced per transmission. For example, 1/8 means one scan line is produced every eight transmissions. "0" freezes the display and it is convenient for observing an echo.

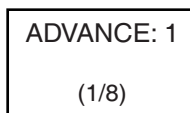

2. Continue pressing the [BRILL] and [AUTO] keys together to select desired speed.

2.7 Display Range Selection

The basic range and range shifting functions used together give you the means to select the depth you can see on the screen. The basic range can be thought of as providing a "window" into the water column and range shifting as moving the "window" to the desired depth.

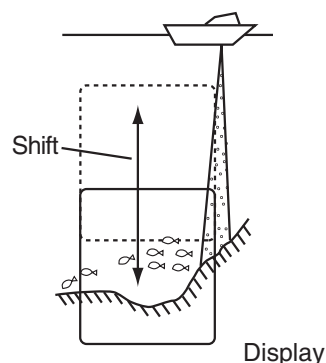

2.7.1 Basic range selection

The basic range may be selected with the [RANGE] switch from the eight ranges shown in the table below.

Table 1-1 Basic ranges (default settings)

Range No.	1	2	3	4	5	6	7	8
Meters	5	10	20	40	80	150	200	300
Feet	15	30	60	120	200	400	600	1000
Fathoms	3	5	10	20	40	80	100	150
Passi/Braza (P/B)	3	5	10	30	50	100	150	200

Operate the [RANGE] switch and the display shown below appears. Adjust the [RANGE] control again to select a basic range.

RANGE: 30 ft

Note: The [RANGE] switch is inoperative when the auto function is active.

2.7.2 Range shifting

The basic range may be shifted up or down with the [SHIFT] keys ([+], [-]). Press a [SHIFT] key and the display shown below appears. Press a [SHIFT] key again to select the amount of shift.

SHIFT: 0 ft

Note 1: The maximum shift range is 1000 feet (300 m). However, actual range will depend on underwater conditions. In the worst case echoes will not appear.

Note 2: Basic ranges can be changed on the system menu [3].

Note 3: The unit of depth may be selected on the system menu [1].

Note 4: The range cannot be shifted when the auto function is active.

2.8 Erasing Weak Echoes

Dirty water or reflections from plankton may be painted on the display in green or light-blue. These weak echoes may be erased as follows:

1. Press the [SIG LEV] key. The following display appears.

SIGLVL: 1

2. Press the [SIG LEV] key again to select signal level (echo color) to erase. Every pressing deletes the weakest color echoes on the screen, up to the light-blue echoes. You may identify the deleted colors on the color bar; deleted colors disappear from the color bar. The selected level is shown as SL1, SL2 or SL3 at the top of the screen. Signal level "0" disables this function.

2.9 Measuring Depth to a Fish School

The VRM (Variable Range Marker) functions to measure the depth to fish schools or other echo.

1. Press [▲] or [▼] to place the VRM on an echo.
2. Read the VRM range just above the VRM.

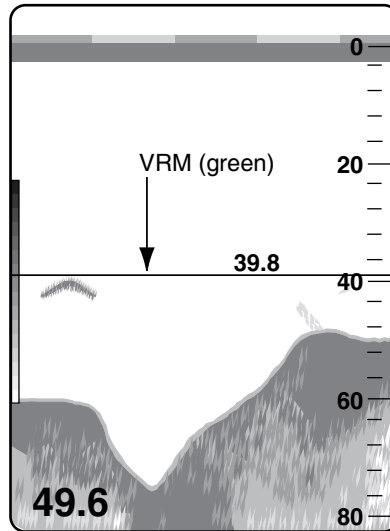

2.10 A-scope Display

This display shows echoes at each transmission with amplitudes and tone proportional to their intensities, on the right 1/4 of the screen. It is useful for estimating the kind of fish school and bottom composition. To turn the A-scope display on or off press the [SIG LEV] and [ALARM] keys together.

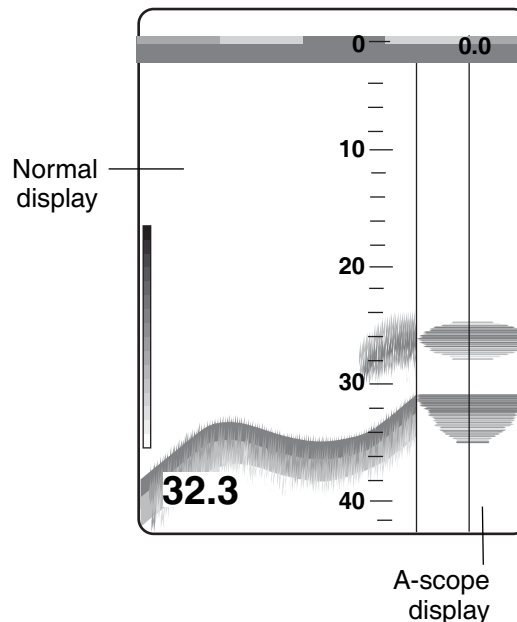

2.11 Menu Operation

The menu, consisting of the main menu and three system menus, contains less often used functions which do not require frequent adjustment.

2.11.1 Menu selection

1. Set the [MODE] switch in the MENU position.

NOISE LIMITER	
<input checked="" type="radio"/>	OFF 1 2 3
HUE SELECTION	
<input type="text" value="1"/>	(1 - 7)
GAIN ADJUST 200KHZ	
<input type="text" value="0"/>	(-20 - +20)
GAIN ADJUST 50KHZ	
<input type="text" value="0"/>	(-20 - +20)
CLUTTER LEVEL	
<input type="text" value="0"/>	* (0 - 3)
ZOOM MODE (B. LOCK)	
M/Z	<input type="text" value="B/L"/> B/Z

▲/▼ : TO SELECT ITEM, 1/2
-/+ : TO SET CONDITION.

* A shown when auto mode is active.

2. To go to page 2 of the main menu, select ZOOM MODE (B. LOCK) with [▼] and then press [▼] again.

MARKER (VRM)	
<input checked="" type="radio"/>	VRM WHT
GO TO SYSTEM MENU	
<input type="text" value="NO"/>	YES

▲/▼ : TO SELECT ITEM, 2/2
-/+ : TO SET CONDITION.

3. To go to the system menu, press [▼] to select GO TO SYSTEM MENU and [+] to select YES. You can switch among system menus by selecting MENU and using [+] or [-].

(* SYSTEM MENU [1] *)
MENU: [1] [2] [3]
 DEPTH: m [ft] fa PB
 SPEED: [kt] MPH KPH
 TEMP: °C [°F]
 ZOOM MARK: [OFF] ON
 F/A LEVEL: WEAK [MED] STRG
 NAV: [GRPH] DATA

▲/▼ : TO SELECT ITEM.
 -/+ : TO SET CONDITION.

(* SYSTEM MENU [2] *)
MENU: [1] [2] [3]
 NAV DSP: [OFF] L/L R/B CSE
 FORMAT: [NMEA] CIF
 SPD SEL: OFF [OWN] NMEA
 TMP SEL: OFF [OWN] NMEA
 TMP GRP: OFF LOW [HIGH]
 SPD ADJ: [+0] % [-50 - +50]
 TMP ADJ: +0.0 °F [-20 - +20]
 (ADJUSTABLE OWN SENSOR ONLY.)

OWN SENSOR OWN SENSOR
 SPEED TEMPERATURE
 0.0 kt °F

▲/▼ : TO SELECT ITEM.
 -/+ : TO SET CONDITION.

(* SYSTEM MENU [3] *)
MENU: [1] [2] [3]
 RANGE1: [15] (10 - 1000)
 RANGE2: [30]
 RANGE3: [60]
 RANGE4: [120]
 RANGE5: [200]
 RANGE6: [400]
 RANGE7: [600]
 RANGE8: [1000]
 ZOOM RANGE: X2 X3 [X4] X5
 B/L RANGE: 10 [20]

▲/▼ : TO SELECT ITEM.
 -/+ : TO SET CONDITION.

4. Press [▲] or [▼] to select menu item.
5. Press [+] or [-] to set condition.
6. Set the [MODE] switch in any other position to register selection and close the menu.

2.11.2 Main menu description

Menu item	Description
NOISE LIMITER	Eliminates noise from other echo sounders and electrical interference.
HUE SELECTION	Selects colors for echoes and background.
GAIN ADJUST (50KHZ, 200KHZ)	Adjusts the gain for both high and low frequencies. Changing this setting by 10 is equal to changing the GAIN control by 1. If the sensitivity is too low or the auto function does not work properly when the transducer is installed inside the hull, try to adjust the gain here.
CLUTTER LEVEL	Eliminates blue dots, which are mainly caused by unclean water, from the screen.
ZOOM MODE	Selects the type of zoom display. B/L, Bottom-lock; B/Z, Bottom zoom, and M/Z, Marker zoom.
MARKER	Selects which marker to use; VRM or white marker.
GO TO SYSTEM MENU	Select YES to go to the system menu.

2.11.3 System menu description

Menu item	Description
System Menu 1	
DEPTH	Selects unit of depth measurement; meters, feet, fathoms, passi/braza.
SPEED	Selects unit of speed measurement; knots, miles per hour, kilometers per hour.
TEMP	Selects unit of temperature measurement; Celsius and Fahrenheit.
ZOOM MARK	Turns zoom range and expansion range markers on/off.
F/A LEVEL	Sets fish alarm level. WEAK: Alarm against weak to strong echoes. MED: Alarm against medium to strong echoes. STRG: Alarm against strong echoes only.
NAV	Selects digital or analog display of navigation data.
System Menu 2	
NAV DSP	Selects digital data to display at top-left corner on the screen. L/L, latitude and longitude position; R/B, Range and bearing to waypoint, CSE, Ship's course.
FORMAT	Selects format of data fed from nav sensor. CIF (FURUNO developed) is standard data format of FURUNO equipment.
SPD SEL	Selects source of speed data. OWN, speed data fed by optional speed sensor; NMEA, speed data fed by position-fixing equipment.
TMP SEL	Selects source of water temperature data. OWN, water temperature data fed by optional water temperature sensor; NMEA, water temperature data fed by position-fixing equipment.
TMP GRP	Turns temperature graph on/off. Requires water temperature sensor. OFF: No water temperature graph. LOW: Temperature graph scale 30°F to 70°F (0°C to 20°C) HIGH: Temperature graph scale 50°F to 90°F (10°C to 30°C)
SPD ADJ	Offsets speed measured by optional speed sensor. When the speed indication appears to be wrong, apply an offset here. Speed data fed from position-fixing equipment cannot be compensated.
TMP ADJ	Offsets water temperature measured by optional speed sensor. When the water temperature indication appears to be wrong, apply an offset here. Water temperature data fed from position-fixing equipment cannot be compensated.
System Menu 3	
RANGE 1-8	Sets basic ranges. Change when default ranges are not satisfactory.
ZOOM RANGE	Selects range scale for bottom zoom and marker zoom displays. X2, for example, expands echoes to double size relative to those on the normal display.
B/L RANGE	Selects range for bottom-lock expansion display.

2.12 Suppressing Interference

Interference from other acoustic equipment operating nearby or other electronic equipment on your boat may show itself on the display as shown below.

To suppress interference, do the following:

1. Select MENU with the [MODE] switch.
2. Select NOISE LIMITER.
3. Press [+] or [-] to select degree of suppression desired. "3" provides the highest degree of suppression.



Interference from
other sounder

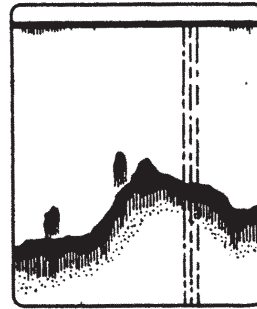

Electrical interference

Turn the noise limiter circuit off when no interference exists, otherwise weak echoes may be missed.

2.13 Suppressing Low Level Noise

Light-blue dots may appear over most of screen. This is mainly due to unclean water or noise. This noise can be suppressed by adjusting CLUTTER on the menu.

When the automatic mode is on, the clutter suppression setting is fixed at AUTO. To suppress low level noise in manual sounder operation do the following:

1. Select MENU with the [MODE] switch.
2. Select CLUTTER LEVEL.
3. Press [+] or [-] to select degree of suppression desired. "3" provides the highest degree of suppression.

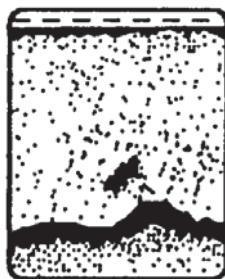

Low level noise

2.14 Selecting Background and Echo Colors

1. Select MENU with the [MODE] switch.
2. Select HUE SELECTION.
3. Press [+] or [-] to select hue arrangement desired, referring to the table below.

Hue options

Hue No.	Background color	Echo color
1	Blue	7 colors, bottom red
2	Blue	6 colors, bottom red
3	Black	7 colors, bottom reddish-brown
4	Black	6 colors, bottom red
5	White	7 colors, bottom red
6	White	6 colors, bottom reddish-brown
7	Black	Monochrome yellow, 8 intensities

2.15 Alarms

2.15.1 Alarm description

Bottom alarm

The bottom alarm sounds when the bottom is within the alarm range set. To activate the bottom alarm the depth must be displayed.

Fish alarm

The fish alarm sounds when fish of a certain strength are within the preset alarm range. The echo strength which triggers the fish alarm can be selected on the system menu [1] with F/A LEVEL.

Water temperature alarm

There are two types of water temperature alarms: IN and OUT. The IN alarm sounds when the water temperature is within the range set; the OUT alarm sounds when the water temperature is higher than the range set. This alarm requires water temperature data.

2.15.2 Activating/deactivating an alarm

1. Press the [ALARM] key to display the alarm menu.

BOTTOM	OFF	ON
ALARM ZONE:	<input type="text" value="0"/>	---
RANGE :	<input type="text" value="5"/>	
FISH	OFF	ON
ALARM ZONE:	<input type="text" value="0"/>	---
RANGE :	<input type="text" value="5"/>	
TEMP	OFF	IN OUT
ALARM ZONE:	<input type="text" value="32"/>	---
RANGE :	<input type="text" value="37"/>	
▲/▼ : TO SELECT ITEM.		
-/+ : TO SET CONDITION.		

2. Press [▲] or [▼] to select an alarm.
3. Press [+] to select ON, IN or OUT. (For the water temperature alarm, select IN to get the alarm when the water temperature is within the alarm zone range, or OUT to get the alarm when the water temperature is higher than the alarm zone range.)
4. Press [▼] to select ALARM ZONE.
5. Adjust width of alarm zone with [+] or [-].

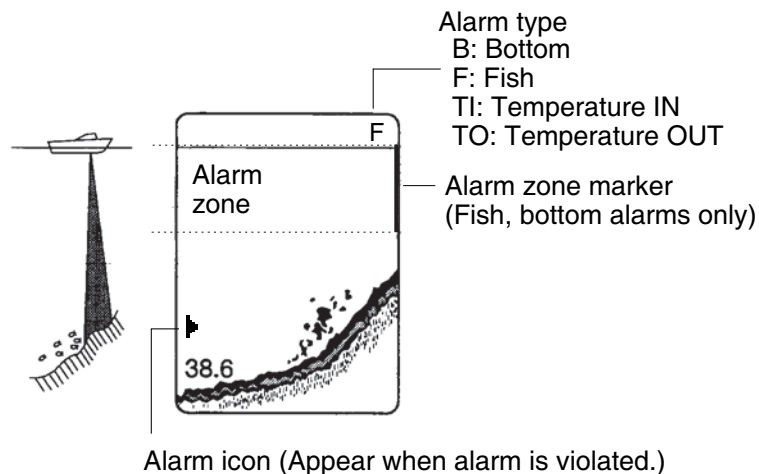

6. Press [▼] to select RANGE.
7. Use [+] to [-] to set display range for the alarm.

To deactivate an alarm, select OFF at step 3 in the above procedure.

2.15.3 Silencing the buzzer

When an alarm is violated, the buzzer sounds and the alarm icon and name of alarm violated (see illustration above) appear on the display. You can temporarily silence the buzzer by pressing the [ALARM] key. However, the buzzer will sound the next time the alarm setting is violated.

2.16 White Marker

The white marker functions to display a particular echo color in white. For example, you may want to display the bottom echo (reddish-brown) in white to discriminate fish echoes near the bottom. Note that the bottom must be displayed in reddish-brown for the white marker to function.

1. Set the [MODE] switch in the MENU position.
2. Press [▼] until page 2 of the main menu appears.
3. Select WHT from the MARKER field.
4. Set the [MODE] switch in desired mode position.
5. Press [▲] or [▼] to select color to display in white. The indication WHITE MARKER appears. As you press those keys the white cursor on the color bar shows the color currently selected to display in white.

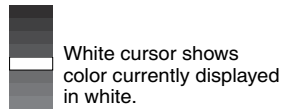

2.17 Demonstration Picture

Your unit incorporates a convenient demonstration display to help you become acquainted with how it works. Connection of the transducer is not required.

1. Turn on the equipment while pressing any key. The following display appears.

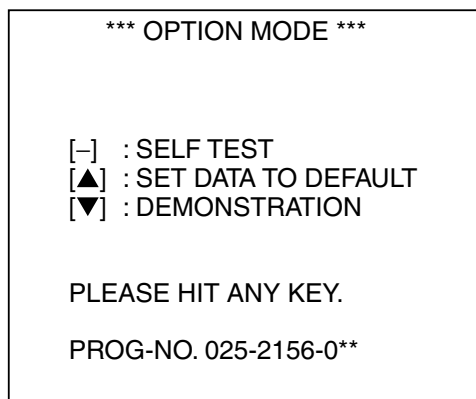

** Program version No.

2. Press [▼] to select DEMONSTRATION. The following display appears.

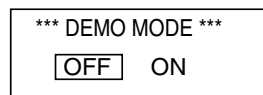

3. Press [+] to select ON.
4. Turn the power off and on again.
5. To turn off the demonstration mode, press [-] to select OFF at step 3 in this procedure.

2.18 Correcting Speed/Water Temperature Readout

Wrong ship's speed or water temperature indication can be corrected on the system menu 2 as follows:

1. Set the [MODE] switch in the MENU position.
2. Press [▼] to select ZOOM MODE, and press the key once again to go to page 2 of the menu.
3. Press [▼] to select GO TO SYSTEM MENU and then press [+] to select YES.
4. Use [+] key to select system menu 2.

(* SYSTEM MENU [2] *)

MENU: [1] [2] [3]

NAV DSP : OFF L/L R/B CSE

FORMAT : NMEA CIF

SPD SEL : OFF OWN NMEA

TMP SEL : OFF OWN NMEA

TMP GRP: OFF LOW HIGH

SPD ADJ : +0 % [-50 - +50]

TMP ADJ : +0.0 °F [-20 - +20]

(ADJUSTABLE OWN SENSOR ONLY.)

OWN SENSOR SPEED	OWN SENSOR TEMPERATURE
0.0 kt	°F

▲/▼ : TO SELECT ITEM.
-/+ : TO SET CONDITION.

5. Select SPD ADJ or TMP ADJ as appropriate.
6. Use [+], [-] to enter offset.

This page is intentionally left blank.

3. INTERPRETING THE DISPLAY

3.1 Zero Line

The zero line (sometimes referred to as the transmission line) represents the transducer's position, and moves off the screen when a deep phased range is used.

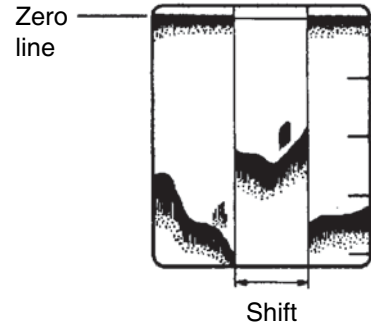

3.2 Fish School Echoes

Fish school echoes will generally be plotted between the zero line and the bottom. Usually the fish school/fish echo is weaker than the bottom echo because its reflection property is much smaller compared to the bottom. The size of the fish school can be ascertained from the density of the display.

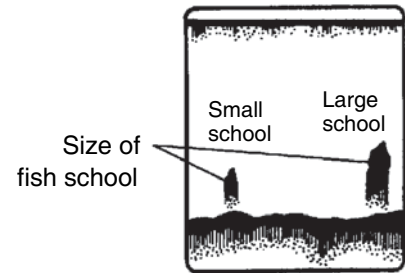

3.3 Bottom Echo

Echoes from the bottom are normally the strongest and are displayed in reddish-brown color (in default color arrangement) but the color and width will vary with bottom composition, water depth, frequency, sensitivity, etc.

In a comparatively shallow depth, a high gain setting will cause a second or sometimes a third or a fourth echo to be displayed at the same interval between them below the first echo trace. This is because the echo travels between the bottom and the surface twice or more in shallow depths.

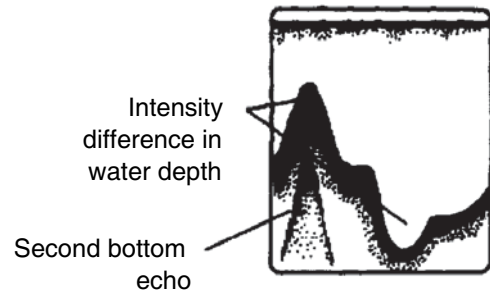

The color of the bottom echo can be used to help determine the density of the bottom materials (soft or hard). The harder the bottom, the wider the trace. If the gain is set to show only a single bottom echo on mud, a rocky bottom will show a second or third bottom return. The range should be chosen so the first and second bottom echoes are displayed when bottom hardness is being determined.

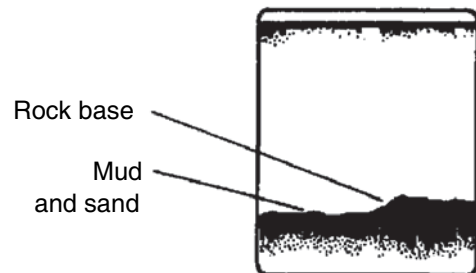

3.4 Surface Noise/Aeration

When the waters are rough or the boat passes over a wake, surface noise may appear near the zero line. As surface turbulence is acoustically equivalent to running into a brick wall, the bottom echo will be displayed intermittently. Similar noise sometimes appears when a water temperature difference (thermocline) exists. Different species of fish tend to prefer different temperature zones, so the thermocline may be useful to help identify target fish. 200 kHz tends to show shallow thermoclines better than 50 kHz.

In rough waters the display is occasionally interrupted due to below-the-ship air bubbles obstructing the sound path. This also occurs when the boat makes a quick turn or reverses movement. Lowering the picture advance speed may reduce the interruption. However, reconsideration of the transducer installation may be necessary if the interruption occurs frequently.

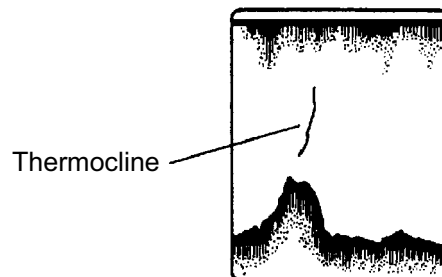
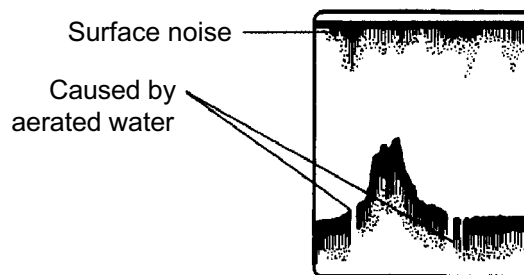

4. MAINTENANCE, TROUBLESHOOTING

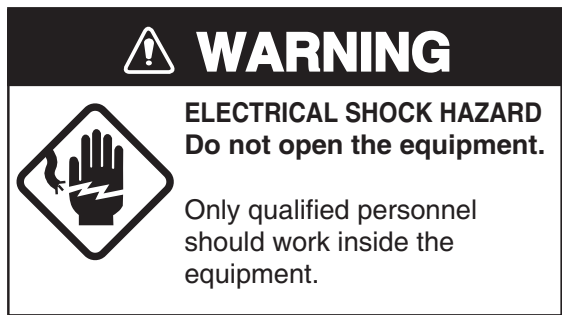

4.1 Maintenance

Regular maintenance is important for good performance. Following the recommended maintenance procedures will help keep your set in good working condition.

4.1.1 General checking

Important points to be checked from time to time are tabulated below.

Maintenance check points

Check point	Action
Transducer cable	If conductors are exposed, replace cable.
Power cable plug/transducer cable plug	If loosened, tighten.
Display unit ground	If corroded, clean.
Ship's mains voltage	If out of ratings, correct problem.

4.1.2 Replacement of fuse

The fuse on the power cable protects the equipment against overvoltage/reverse polarity of the ship's mains or internal fault of the equipment. If the fuse blows, find the cause before replacing the fuse. If the fuse blows again after replacement, call for service. A fuse rated for more than 3A should not be used since it would damage the equipment and void the warranty.

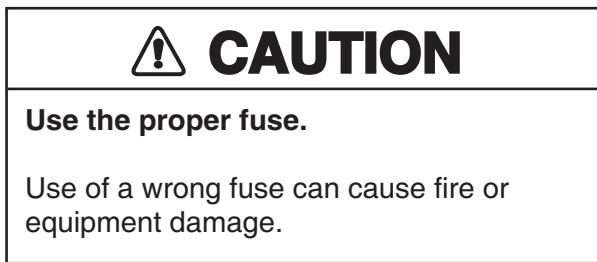

4.1.3 Cleaning

Keep the equipment clean and dry at all times. Dust or loose dirt should be wiped off with a soft, dry cloth. Do not use chemical cleaners to clean the display unit - they can remove paint or markings.

4.1.4 Maintenance of the transducer

Marine life on the transducer face will result in gradual decrease in the sensitivity. Check the transducer face for cleanliness each time the boat is hauled out of the water. Carefully remove any marine life with a piece of wood or fine sandpaper.

4.2 Basic Troubleshooting

The troubleshooting table below presents common problems and the means to restore normal operation. If normal operation cannot be restored do not attempt to check inside the equipment.

Basic troubleshooting

If...	Then
neither echo nor fixed range scale appears	<ul style="list-style-type: none"> • check battery voltage. • check fuse. • check battery terminal for corrosion. • check that power cable is securely plugged.
no echo but range scale shows	<ul style="list-style-type: none"> • check if display speed is set to "0." • check if transducer plug is firmly connected.
echo appears but no zero line	<ul style="list-style-type: none"> • check if range shifting is set to "0."
the equipment shows signs of low sensitivity	<ul style="list-style-type: none"> • check if gain setting is suitable. • check for air bubbles or marine life attached to transducer. • check if water is dirty. • bottom may be too soft to return proper echo.
no water depth readout is shown	<ul style="list-style-type: none"> • check if bottom echo is painted red or reddish-brown. • check if bottom is displayed.
much noise or interference is present	<ul style="list-style-type: none"> • check if transducer/transducer cable is too close to engine. • check unit ground. • check if there are other echo sounders of the same frequency nearby.
speed/water temperature indication* is absent or unrealistic	<ul style="list-style-type: none"> • check that sensor plug is securely fastened.
position indication* is absent or unrealistic	<ul style="list-style-type: none"> • check that sensor plug is securely fastened. • check position-fixing equipment.

* Requires appropriate sensor.

4.3 Diagnostics

Your equipment incorporates a diagnostic test facility to check the devices and controls for proper operation.

1. Turn on the unit while pressing any key. The following display appears.

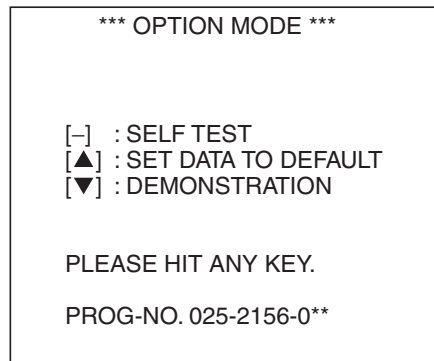

** Program version No.

2. Press the [-] key to start the diagnostic test. The diagnostics screen appears, devices are checked and the results displayed as OK or NG (No Good).
3. Operate all controls one by one. Confirm that key name and switch position are correct.

Note: Do not place the [MODE] switch in the POWER OFF position; power will be turned off.

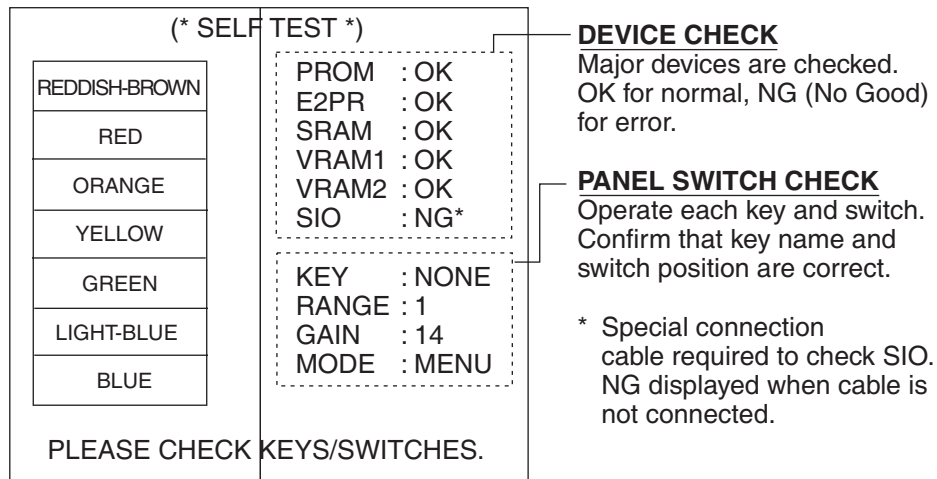

Note: If NG appears instead of OK for any device or panel switch, contact FURUNO for service. Do not attempt to check inside the unit because of the high voltage used in the equipment.

4. To terminate the test, turn the power off.

4.4 Transducer Check

A simple and reliable check of the transducer is to temporarily replace the transducer with a new one. If the sensitivity is considerably improved through this change, the transducer is probably faulty. This method is especially useful for inside-hull or through-hull installation.

Another method is to listen to the transmission sound. Haul the transducer from the water and turn on the power. Put your ear near the transducer face and carefully listen to the transmission sound. If you can hear a clicking sound, the transducer is probably normal. Next, rub the transducer face with your hand and observe whether noise appears on the screen. The appearance of noise indicates the transducer is normal. In case of neither sound nor noise, the transducer is probably faulty.

4.5 Speed/Water Temperature Sensor (option) Check

The idea of the transducer check can apply to this case, too; temporarily substitute a new sensor. If the speed/temperature indications become normal, your sensor may be faulty.

When a new sensor is not available, try to turn the water wheel with a finger. If the sensor is normal, the speed indication will be two to three knots when the wheel is turned slowly and seven to eight knots when turned more quickly. As for the water temperature, the water temperature indication should change when you touch the thermosensor.

4.6 Restoring Default Settings

1. Turn on the unit while pressing any key. The following display appears.

```
*** OPTION MODE ***

[-] : SELF TEST
[▲] : SET DATA TO DEFAULT
[▼] : DEMONSTRATION

PLEASE HIT ANY KEY.

PROG-NO. 025-2156-0**
```

** Program version No.

2. Press [▲] to restore default settings. The message SET DATA TO DEFAULT! appears. After default settings are restored, the message is erased and the normal display appears. See the next page for default settings.

This page is intentionally left blank.

MENU TREE

[MODE] switch in MENU position

NOISE LIMITER
 OFF 1 2 3

HUE SELECTION
 1 (1 - 7)

GAIN ADJUST 200KHZ
 0 (-20 - +20)

GAIN ADJUST 50KHZ
 0 (-20 - +20)

CLUTTER LEVEL
 0 (0 - 3)

ZOOM MODE (B. LOCK)
M/Z B/L B/Z

▲/▼ : TO SELECT ITEM, 1/2
-/+ : TO SET CONDITION.

Press ▼ at ZOOM MODE.

MARKER(VRM)
 VRM WHT

GO TO SYSTEM MENU
 NO YES

▲/▼ : TO SELECT ITEM, 2/2
-/+ : TO SET CONDITION.

Default settings are circumscribed.

DEFAULT CONTROL SETTINGS	
SHIFT:	0
BRILL:	6
ADVANCE:	4
SIG LEV:	0
ALARM:	OFF
A-SCOPE:	OFF
MARKER:	0

Press [+] at GO TO SYSTEM MENU.

(* SYSTEM MENU [1] *)

MENU: [1] [2] [3]

DEPTH : m ft fa PB

SPEED : kt MPH KPH

TEMP : ° C ° F

ZOOM MARK : OFF ON

F/A LEVEL : WEAK MED STRG

NAV : GRPH DATA

▲/▼ : TO SELECT ITEM.
-/+ : TO SET CONDITION.

Press [-] key.

Press [+] at MENU.

(* SYSTEM MENU [2] *)

MENU: [1] [2] [3]

NAV DSP : OFF L/L R/B CSE

FORMAT : NMEA CIF

SPD SEL : OFF OWN NMEA

TMP SEL : OFF OWN NMEA

TMP GRP: OFF LOW HIGH

SPD ADJ : +0 % [-50 - +50]

TMP ADJ : +0.0 °F [-20 - +20]

(ADJUSTABLE OWN SENSOR ONLY.)

OWN SENSOR SPEED OWN SENSOR TEMPERATURE
0.0 kt °F

▲/▼ : TO SELECT ITEM.
-/+ : TO SET CONDITION.

Press [-] key.

Press [+] at MENU.

(* SYSTEM MENU [3] *)

MENU: [1] [2] [3]

RANGE1 : 15 (10 - 1000)

RANGE2 : 30

RANGE3 : 60

RANGE4 : 120

RANGE5 : 200

RANGE6 : 400

RANGE7 : 600

RANGE8 : 1000

ZOOM RANGE: X2 X3 X4 X5

B/L RANGE: 10 20

▲/▼ : TO SELECT ITEM.
-/+ : TO SET CONDITION.

SPECIFICATIONS OF COLOR VIDEO SOUNDER FCV-667

1. GENERAL

- (1) Display 6-inch diagonal CRT
- (2) Echo Color 8 colors (including background color) according to echo intensity.
Monochrome display is also available. The background color is selectable from blue, light blue, white and black.
- (3) Basic Range Meters: 5/10/20/40/80/150/200/300
Feet: 15/30/60/120/200/400/600/1000
Fathoms: 3/5/10/20/40/80/100/150
Passi/Braza: 3/5/10/30/50/100/150/200
The basic ranges can be changed on the system menu.
- (4) Range Shift Up to 300 meters (1000 feet, 150 fathoms, 200 passi/braza)
- (5) Zoom Range Times 2, 3, 4 and 5 ranges
- (6) Bottom Lock Expansion Range 5/10 meters, 10/20 feet, 2/5 fathoms, 2/5 passi/braza
- (7) Auto Mode Automatic adjustment of range and gain
- (8) Display Mode High Frequency (HF), Low Frequency (LF), Dual (high and low frequency 1/2 display on each), Zoom (high/low freq. And Zoom), NAV (Graphical and numerical displays of water depth, water temperature, ship's speed, L/L data, etc), and A-scope Display
- (9) Zoom Display Marker Zoom, Bottom Zoom and Bottom-lock Expansion
- (10) Display Advance Speed Lines/TX: Freeze, 1/8, 1/4, 1/2, 1/1, 2/1
- (11) TX Frequency/ Output power 50 and 200 kHz (alternately transmitted), 300 W

(12) Pulse-length/TX rate

Display End Depth (m)	5	10	20	40	80	150	300
Pulse-Length (ms)	0.2	0.2	0.2	0.4	0.8	1.5	3.0
TX Rate (pulse/min)	600	600	600	375	187	100	50

- (13) Interference Rejecter Rejects unwanted signals by comparing last and present echoes in strength.
- (14) Alarm Fish and Bottom alarms, Temperature alarm*
- (15) Input/output data NMEA 0183 or CIF format
- Input RMB, BWC, RMC, RMA, GLL, VTG, VHW, MTW, XTE
- Output SDDBT, YCMTW*, VWVHW*, SDDPT
- CIF Input L/L, Ship's speed, Course, Waypoint ID, Range/bearing to Waypoint, Water temperature, Cross-track Error

CIF Output

Depth, Water temperature*, Ship's Speed*

*: Speed/temperature sensor required.

2. POWER SUPPLY

(1) Display Unit 12-24 VDC (-10%, +30%); 2.5-1.25 A

3. ENVIRONMENTAL CONDITION

(1) Ambient Temperature 0°C to +50°C

(2) Relative Humidity 85% at 40°C

(3) Water proofing Display Unit: IPX4

(4) Vibration $\pm 1 \text{ mm} \pm 10\%$, 2(5) to 13.2 Hz,
Maximum acceleration 7 m/s^2 , 13.2 to 100 Hz

4. COATING COLOR

(1) Display Unit Chassis: 2.5GY5/1.5
Panel: N3.0 Newtone No.5

INDEX

Aeration.....	3-2	Interference.....	2-13
Alarms		Main menu.....	2-10
activating.....	2-15	Marker zoom mode.....	2-3
bottom.....	2-14	Menu	
fish.....	2-14	main menu description.....	2-11
silencing buzzer.....	2-15	menu selection.....	2-10
water temperature.....	2-14	system menu description.....	2-12
A-scope display.....	2-9	Menu tree.....	A-1
AUTO key.....	2-6	MODE switch.....	2-1
Automatic operation.....	2-6	Nav data enlargement.....	2-5
Background color.....	2-14	Nav mode.....	2-4
Bottom alarm.....	2-14	Noise limiter.....	2-13
Bottom echoes.....	3-1	Picture advance speed.....	2-7
Bottom zoom mode.....	2-3	Power on/off.....	2-1
Bottom-lock mode.....	2-3	Principle of operation.....	v
BRILL key.....	2-1	RANGE switch.....	2-7
Brilliance.....	2-1	SHIFT keys.....	2-8
Checking.....	4-1	SIG LEV key.....	2-8
Cleaning.....	4-2	Speed indication correction.....	2-17
Clutter.....	2-13	Speed sensor check.....	4-5
Default settings.....	4-5	Surface noise.....	3-2
Demonstration picture.....	2-16	System menu.....	2-12
Depth measurement.....	2-9	Transducer	
Diagnostics (self test).....	4-4	checking.....	4-5
Display mode.....	2-1	maintenance.....	4-2
Dual frequency mode.....	2-2	Troubleshooting.....	4-3
Echo color.....	2-14	VRM.....	2-9
Fish alarm.....	2-14	Water temperature alarm.....	2-14
Fish school echoes.....	3-1	Water temperature graph.....	2-12
Fuse replacement.....	4-1	Water temperature indication correction.....	2-17
GAIN control.....	2-6	Water temperature sensor check.....	4-5
HF, LF mode.....	2-2	White marker.....	2-16
Hue.....	2-14	Zero line.....	3-1
Indications.....	1-2	Zoom mode.....	2-3



(Elemental Chlorine Free)

The paper used in this manual
is elemental chlorine free.

© **FURUNO ELECTRIC CO., LTD.**

9-52 Ashihara-cho,
Nishinomiya 662-8580, JAPAN

Telephone : 0798-65-2111

Fax : 0798-65-4200

FURUNO Authorized Distributor/Dealer

All rights reserved.

Printed in Japan

FIRST EDITION : SEP. 1993

H : NOV. 15, 1999

Pub. No. OME-23450

(DAMI) FCV-667



* 0 0 0 8 0 5 7 8 2 0 0 *



* O M E 2 3 4 5 0 H 0 0 *